



Alumil
Building excellence every day

Alumil  **SUPREME**
SF85



CONTENTS

SUPREME SF85

DESIGN PHILOSOPHY & CHARACTERISTICS	4
UNPARALLELED ADVANTAGES	8
SPECIAL FEATURES & FITTINGS	12
DRAWING SECTIONS	16
APPLICATIONS	30
TABLE OF PERFORMANCE	31

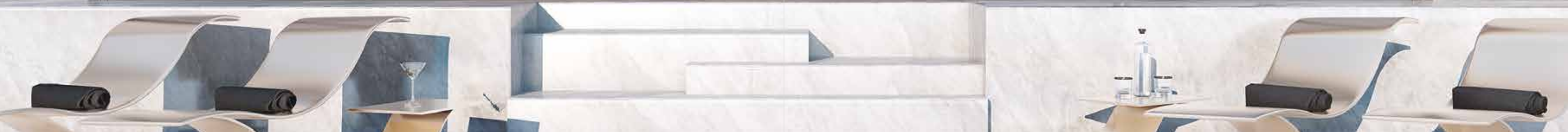

SUPREME SF85

is an exceptional folding door system with minimal design and amazingly narrow sightlines. At the same time, the series offers outstanding performance and the ability to create very large constructions.

Unique folding doors with impressive, minimal design, remarkable thermal insulation and superb overall performance.

Alumil SUPREME
SF85

Excellent **energy efficiency** and **security**, combined with timeless aesthetics and remarkably **oversized** constructions

SUPREME SF85 is ideal for flawless high-end residential and commercial applications, including **heavy-duty constructions**.

DESIGN PHILOSOPHY

Its flexibility and the variety of typologies (e.g. even & odd number of vents, corner typologies and semi-structural sash version), provide numerous construction solutions, meeting every need in a very **effective** and **elegant way**.

CHARACTERISTICS

ADVANTAGES

- Extremely reduced sightlines and unique, minimal design (105mm).
- Very large dimensions in terms of height (up to 4,0 m), vent width (up to 1,5 m) and total construction width.
- Incredibly high thermal insulation for maximum energy saving.
- Outstanding performance in terms of water tightness, air permeability and wind load resistance.
- Enhanced security and burglar protection, thanks to quadruple locking latches and anti-lift mechanism.
- Ultra-smooth and long-lasting operation.



Alumil > SUPREME
SF85

TECHNICAL

CHARACTERISTICS

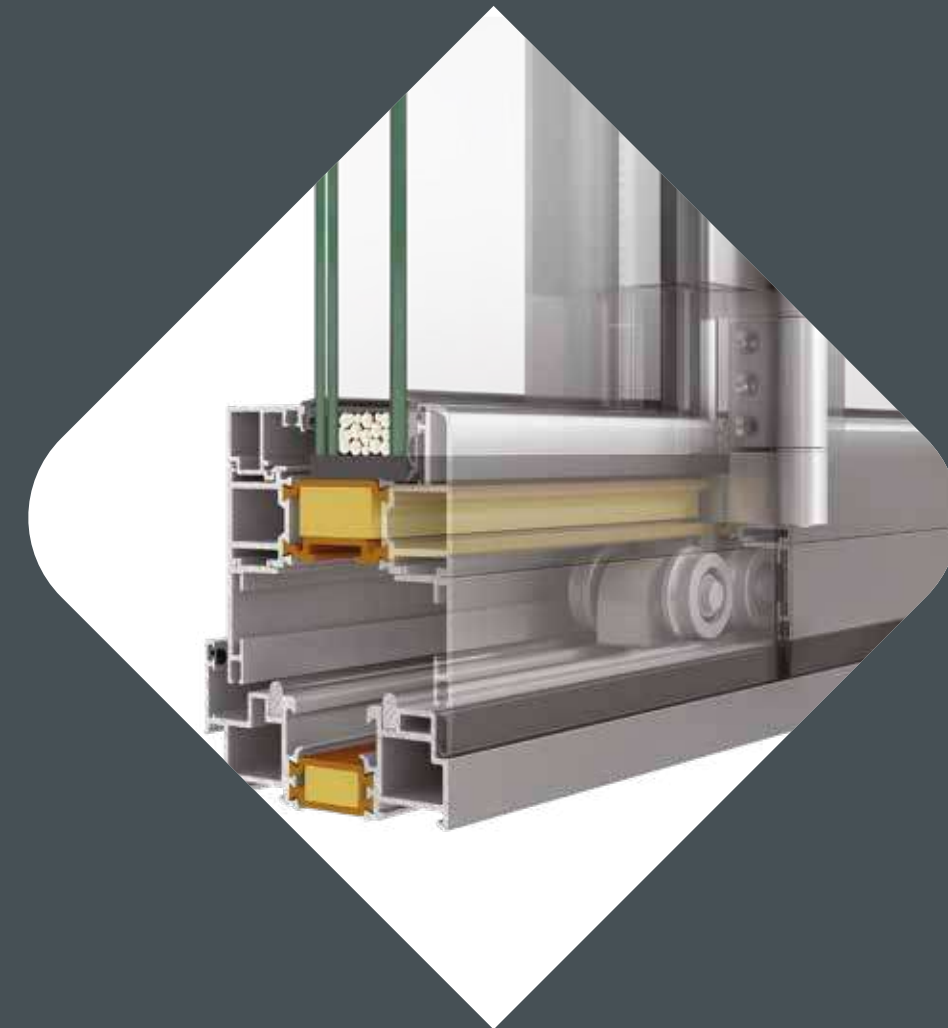

SASH WIDTH	85 mm
SASH TO SASH SIGHTLINE	105 mm
GLAZING	20-53 (STANDARD SASH) 34-75 (SEMI-STRUCTURAL SASH)
THERMAL INSULATION	POLYAMIDES 40 mm WIDTH, ALUMIL NRG BARS INSULATION & PE INSULATION FOAM
MAIN GASKET	CO-EXTRUDED FOAM & EPDM
PANEL LOCKING	QUADRUPLE LATCHES
VENT WEIGHT	UP TO 200 Kg/VENT

TOTAL COMFORT

& SENSE OF FREEDOM

PERFORMANCE & RELIABILITY

Smooth, long-lasting and flawless operation, thanks to the special top and bottom roller-hinges, the heavy-duty hinges and the overall high quality of the system.

Outstanding performance

- Air permeability: class 4
- Wind load resistance: class C3/B3
- Water tightness: class 9A.
- Certified by the ift Rosenheim Institute.



AESTHETICS THAT APPEAL TO EVERYONE

Minimal design with amazingly reduced sightlines and less aluminium, since the system allows constructions of much wider vents and consequently fewer of them are needed to cover large spans (e.g. five vents instead of seven).

- Sash to sash sightline: 105 mm.
- Frame to sash sightline: 110 mm.
- Vent width can reach up to 1,5 m.
- The available semi-structural version can upgrade the aesthetic value of the building even further.

EXTREMELY LARGE DIMENSIONS

The system achieves very large dimensions in terms of:

- Height: up to 4,0 m.
- Total width: possibility for a large number of vents and very wide spans.

Ideal for modern residences, especially when wider vents are required (e.g. 3 vents of 1,5 m width each, instead of 5 vents of 0,90 m width).

Ideal for commercial projects with structures of 4,0 m height and with a large number of vents.

Alumil SUPREME
SF85

EXTREMELY HIGH THERMAL EFFICIENCY

High energy saving with U_w values around $1,0 \text{ W/m}^2\text{K}$, thanks to co-extruded EPDM foam gasket, ALUMIL NRG Bars, 40 mm width polyamides, PE insulation foam and the overall sophisticated design.

TOTAL COMFORT

& SENSE OF FREEDOM

VARIETY AND FLEXIBILITY

Vast variety of folding door solutions, thanks to the numerous typologies and the flexible design of the system.

- Odd number of vents (e.g. 3+0, 7+1, 5+3).
- Even number of vents (e.g. 4+0, 2+1, 4+3, 2+2).
- Corner constructions.
- Semi-structural version.
- Inwards or outwards opening.
- Standard, low and embedded threshold.

TOP LEVEL OF SECURITY

Enhanced burglar protection levels, which meet all industry security standards thanks to:

- Quadrupel shoot bolts from glass reinforced polyamide (instead double) or anodised aluminium.
- Bottom roller-hinge with anti-lift mechanism.
- Profile and hinges sturdiness.
- 5-point lock.
- Possibility for very thick glazing (20-53 mm).



Alumil > SUPREME
SF85



State-of-the-art fittings, specially designed to achieve **unparalleled performance** and **smooth bottom-slide operation**.

ATTENTION

TO DETAIL

SPECIAL TOP ROLLER-HINGE

Though bottom-slide operation, the top roller-hinge, apart from guiding the vents:

- allows smooth operation, thanks to a special spring mechanism.
- is long enough to prevent the vents from rotating during operation.

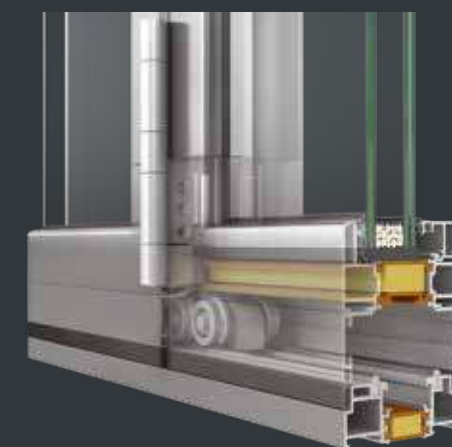
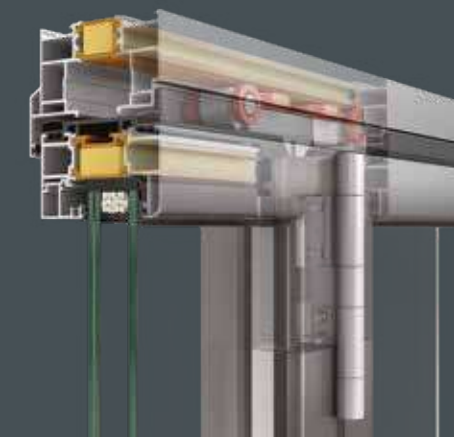

SPECIAL BOTTOM ROLLER-HINGE

- Max weight up to 500 Kg (& 200 per vent).
- Anodised body, stainless steel rollers and rust-protected bearings.
- Allows very large dimensions.
- Enables very easy installation and long-lasting flawless operation.
- Anti-lift prevention fitting for enhanced burglar protection.

FITTINGS FOR EASY HANDLING

- Extremely efficient heavy-duty hinges: three (3) hinges are in most times adequate for a pair of heavy vents.
- Pull-handle attached on the intermediate hinge.
- Special ALUMIL design handle for the intermediate vents.
- ALUMIL design door handle.

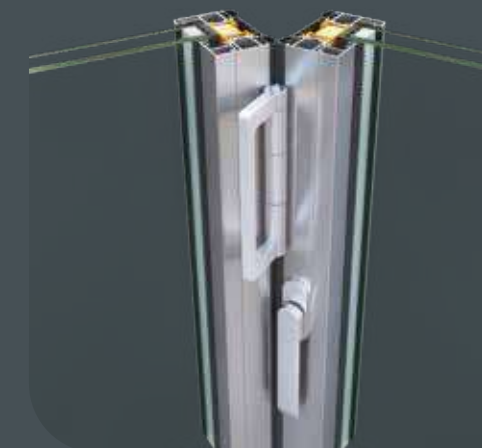

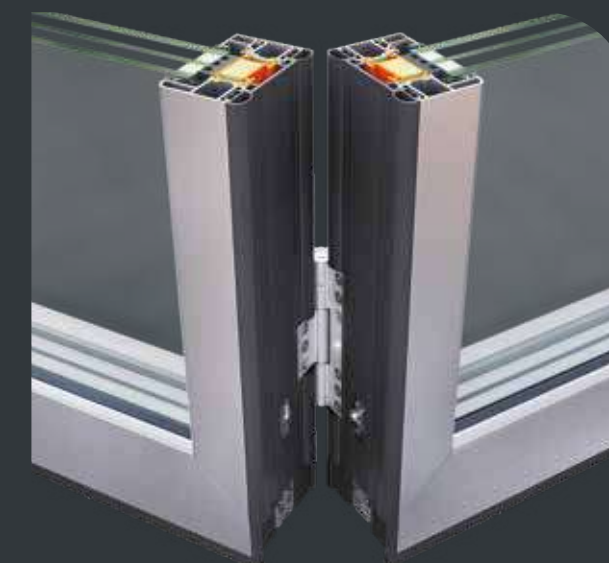

- Intermediate vents locking with special quadruple latches made of glass reinforced polyamide.
- Single co-extruded gasket made of EPDM and foam.
- Double set of glass reinforced polyamides 40 mm.
- ALUMIL NRG bars and PE insulation foam for enhanced thermal insulation.



- Special fittings for the easy adjustment of the double frame profile.
- Option between solid or hollow inox guide rails.
- Enhanced sealing around the hinge, thanks to special rubber fittings.
- Special cap for the milled part of the guide.
- Rubber fitting to cover the guide rail beneath the hinged door.

- Standard version with glazing beads for various glass thicknesses.
- Semi-structural version for a unique result.
- Option between standard or low threshold.



3+0 Opening outwards

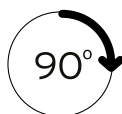
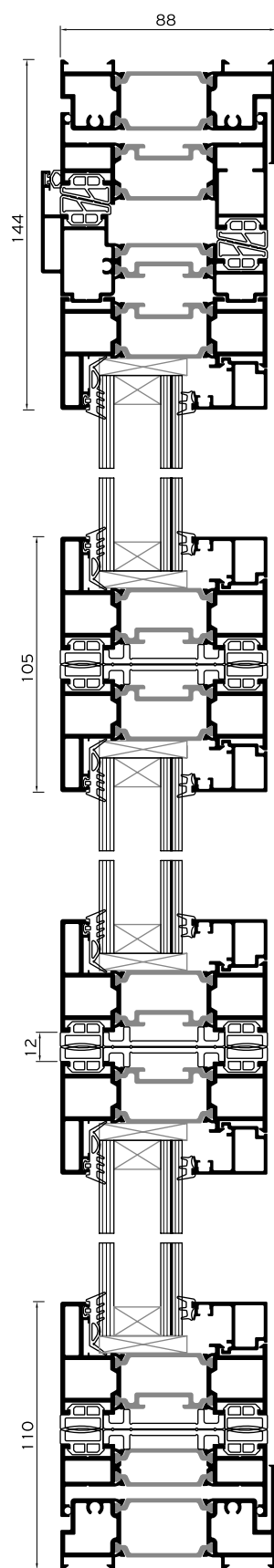
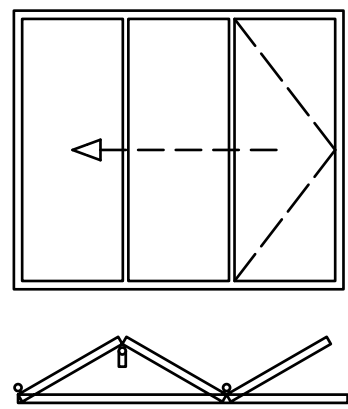

3+0 Opening inwards

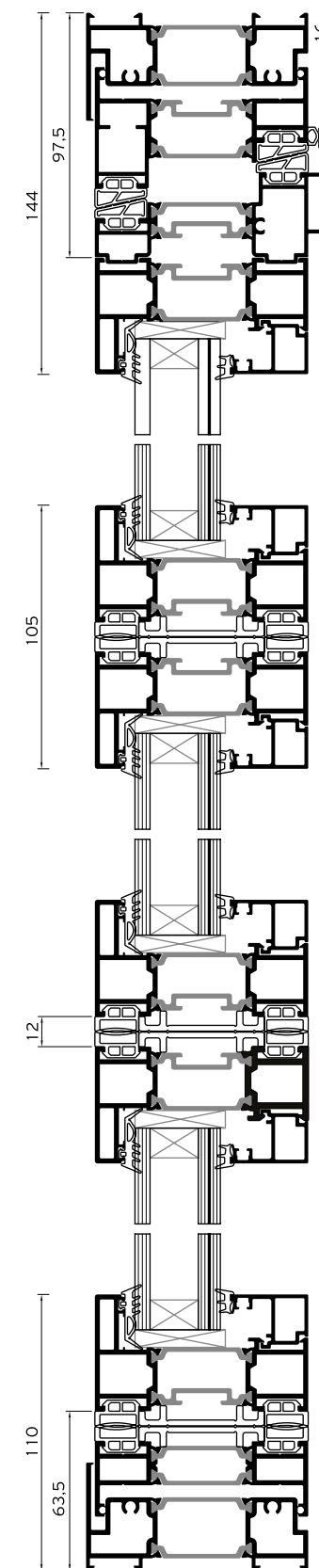
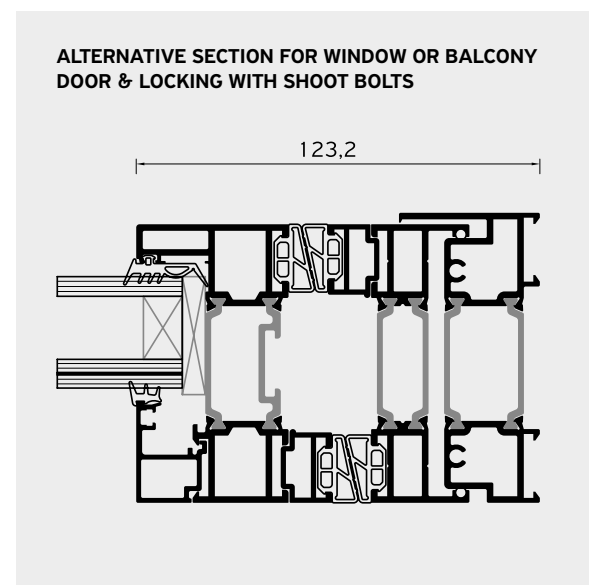
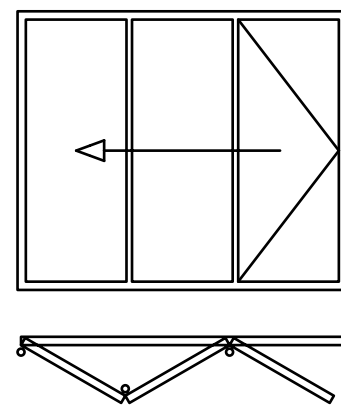

3+1 Opening outwards

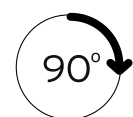
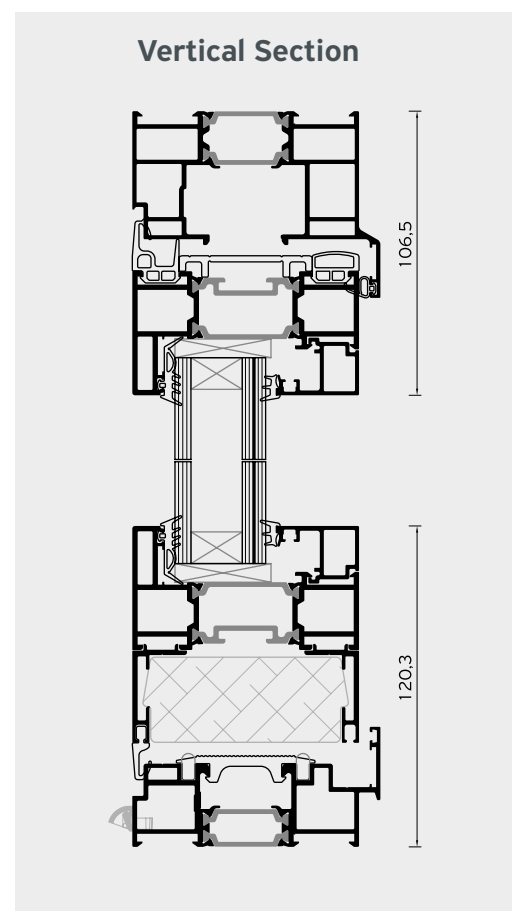
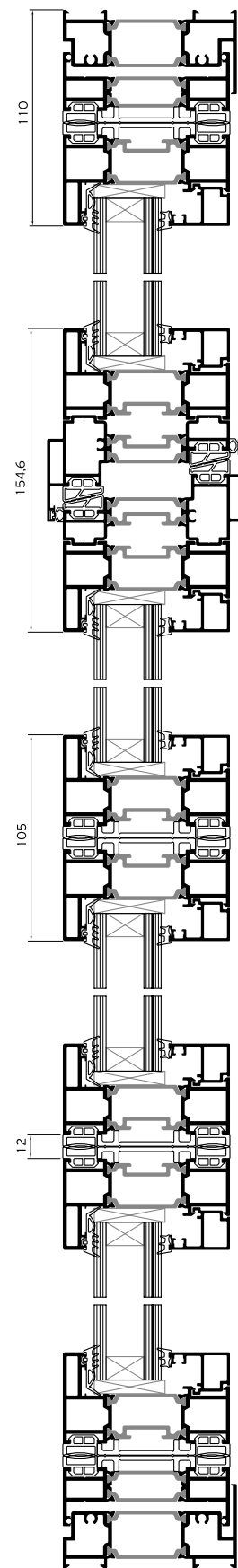
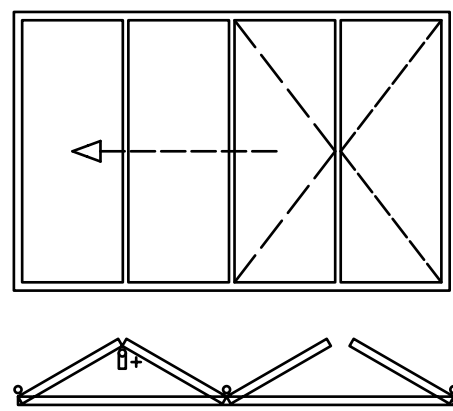

Standard threshold

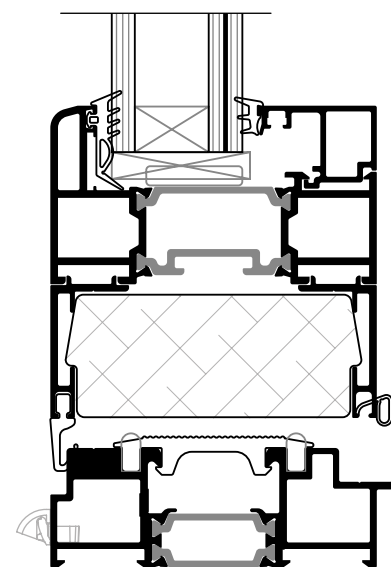

Low threshold

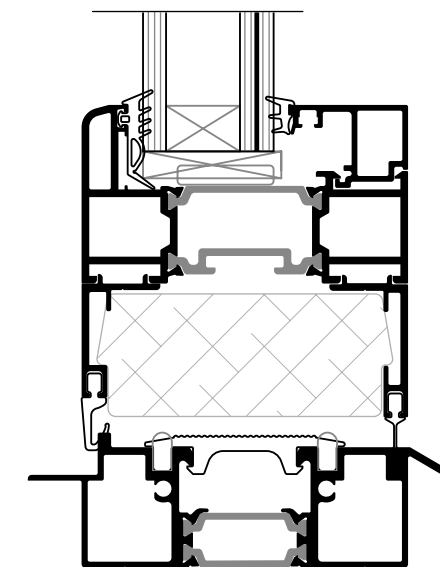

Threshold with subsill

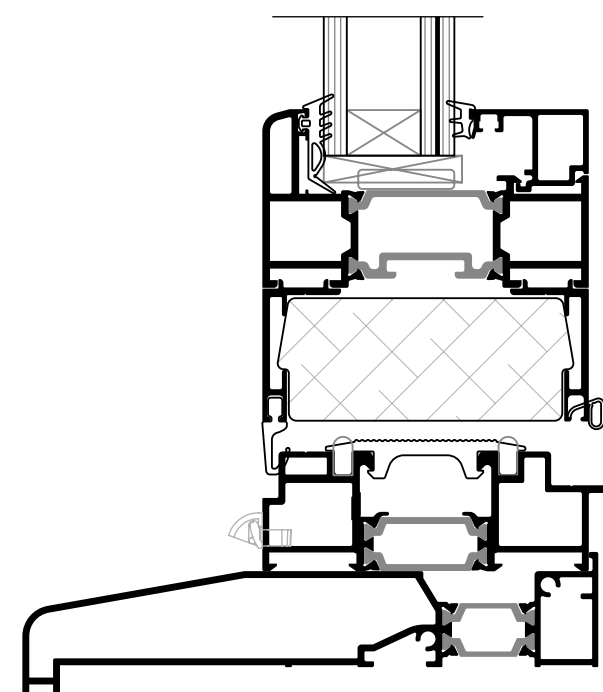

Threshold embedded

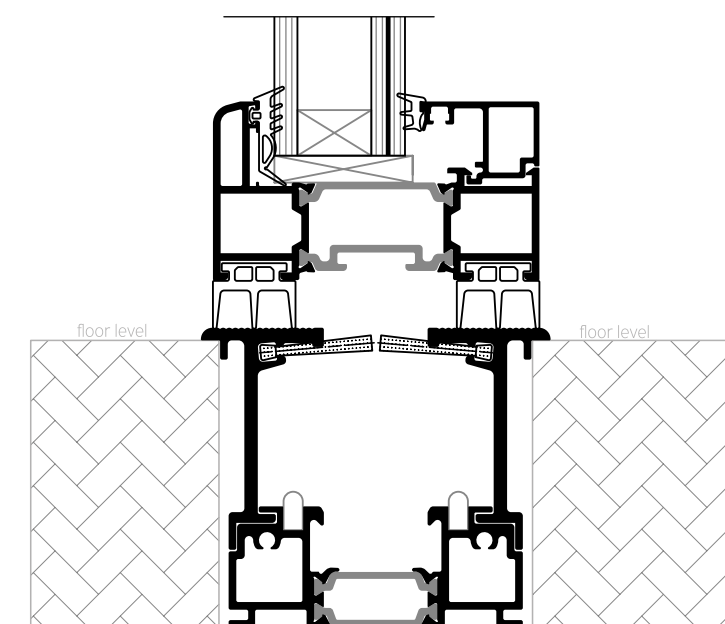

3+3
Opening outwards

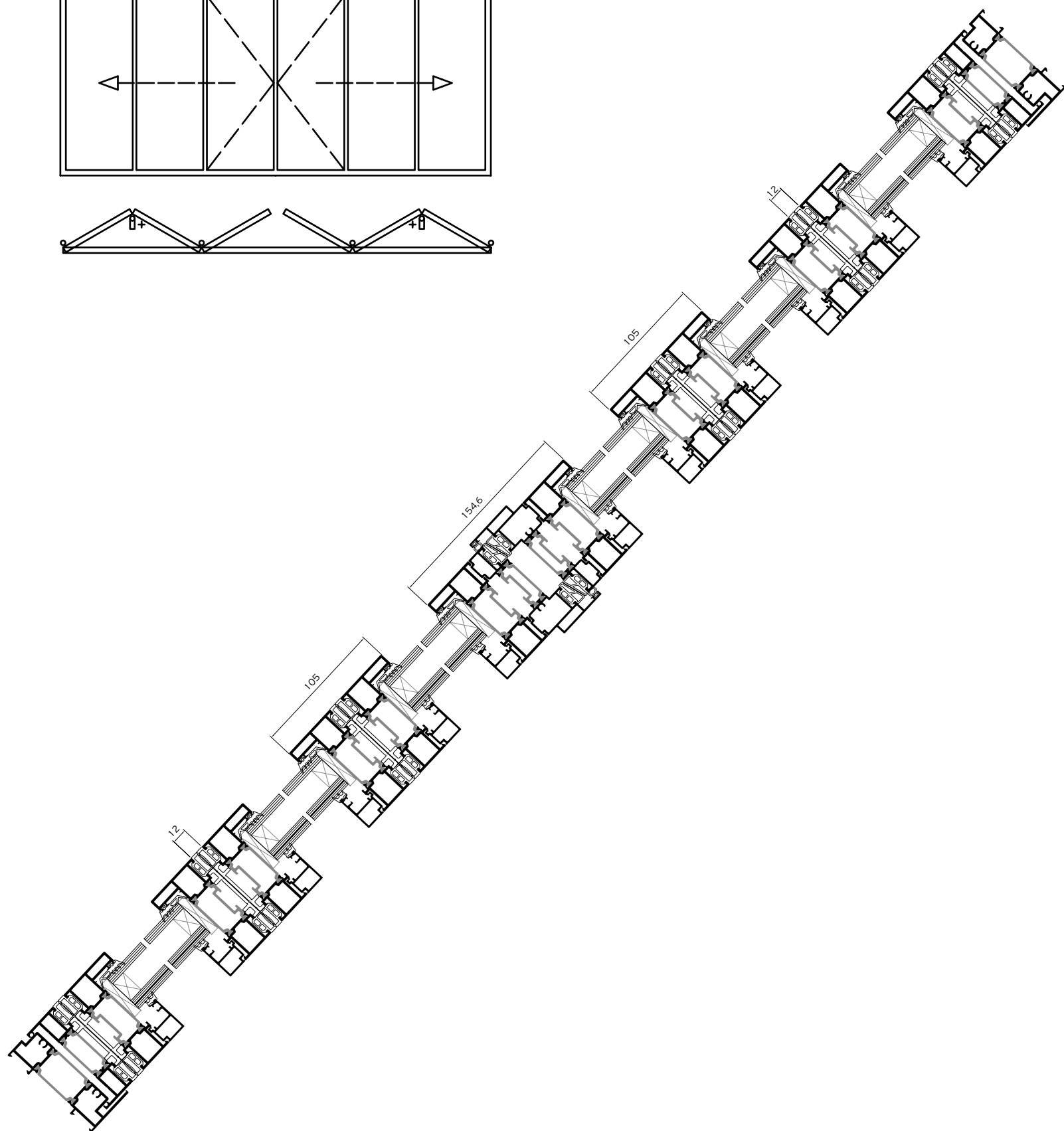
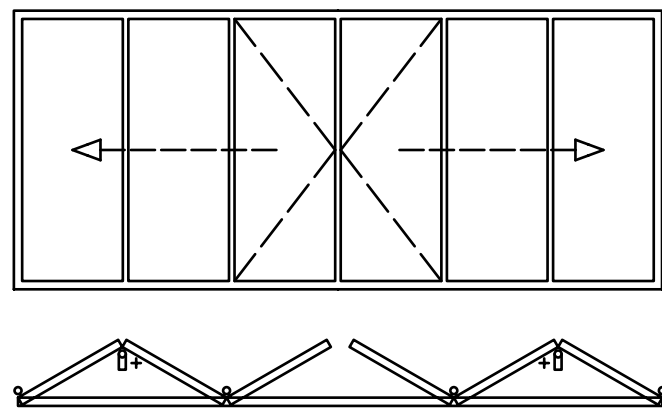

1+1
Opening outwards

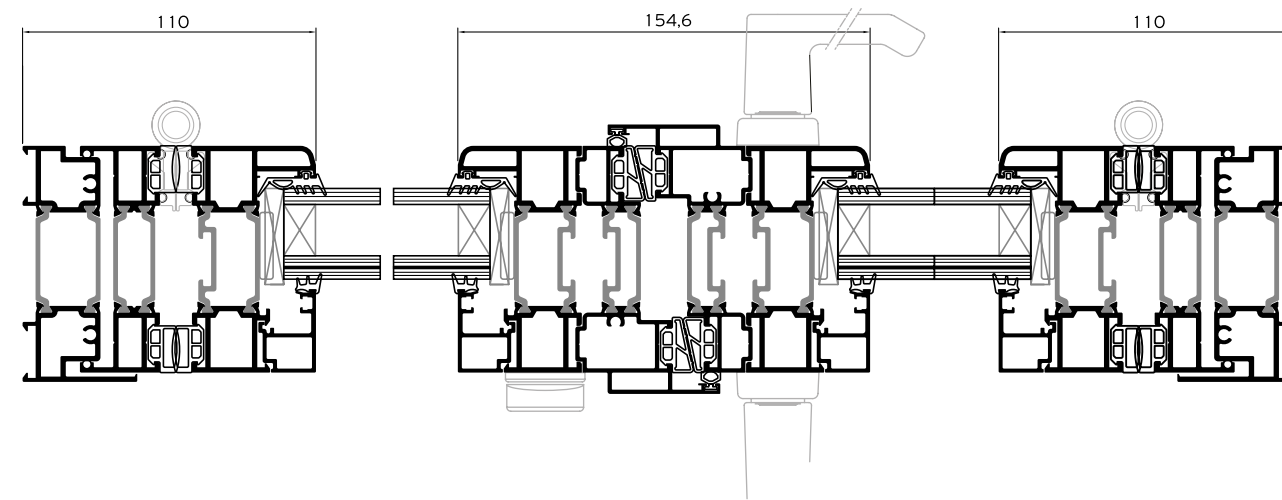
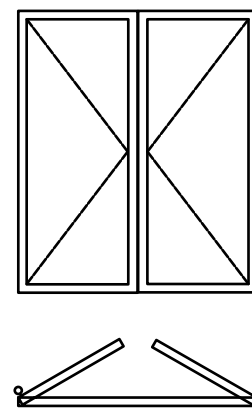

2+0
Opening outwards

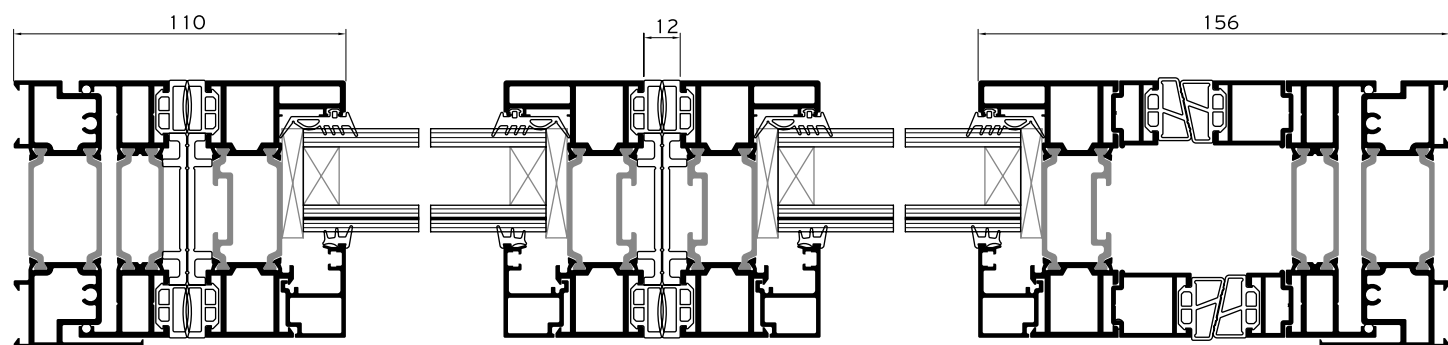
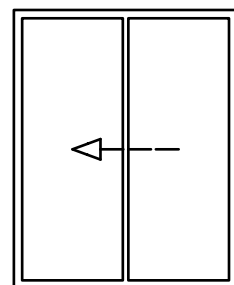

2+3
Opening outwards

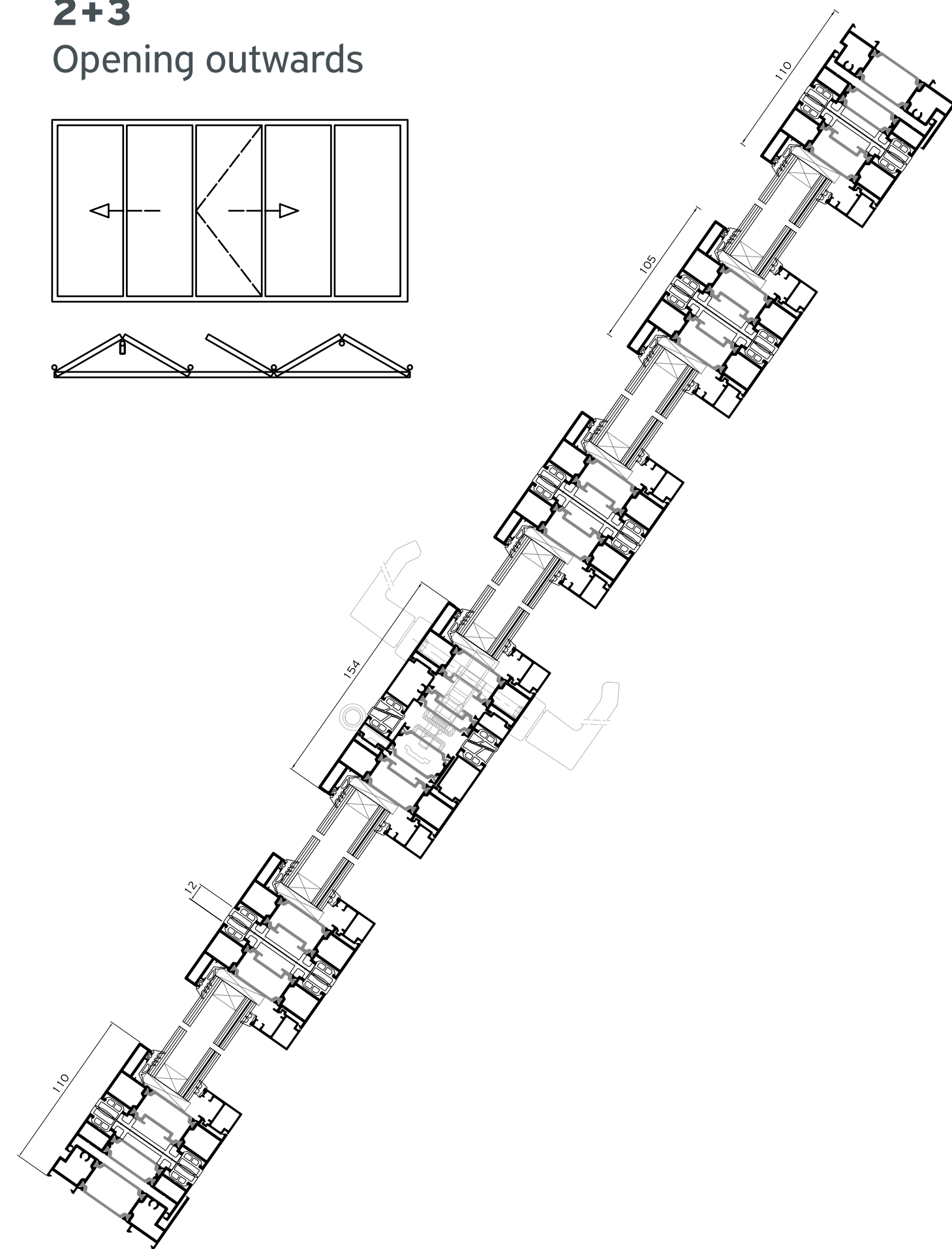
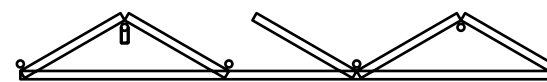
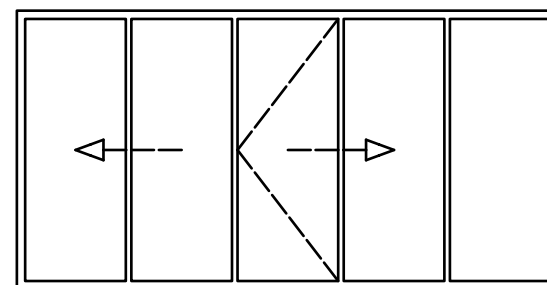

3+3 External Corner Opening outwards

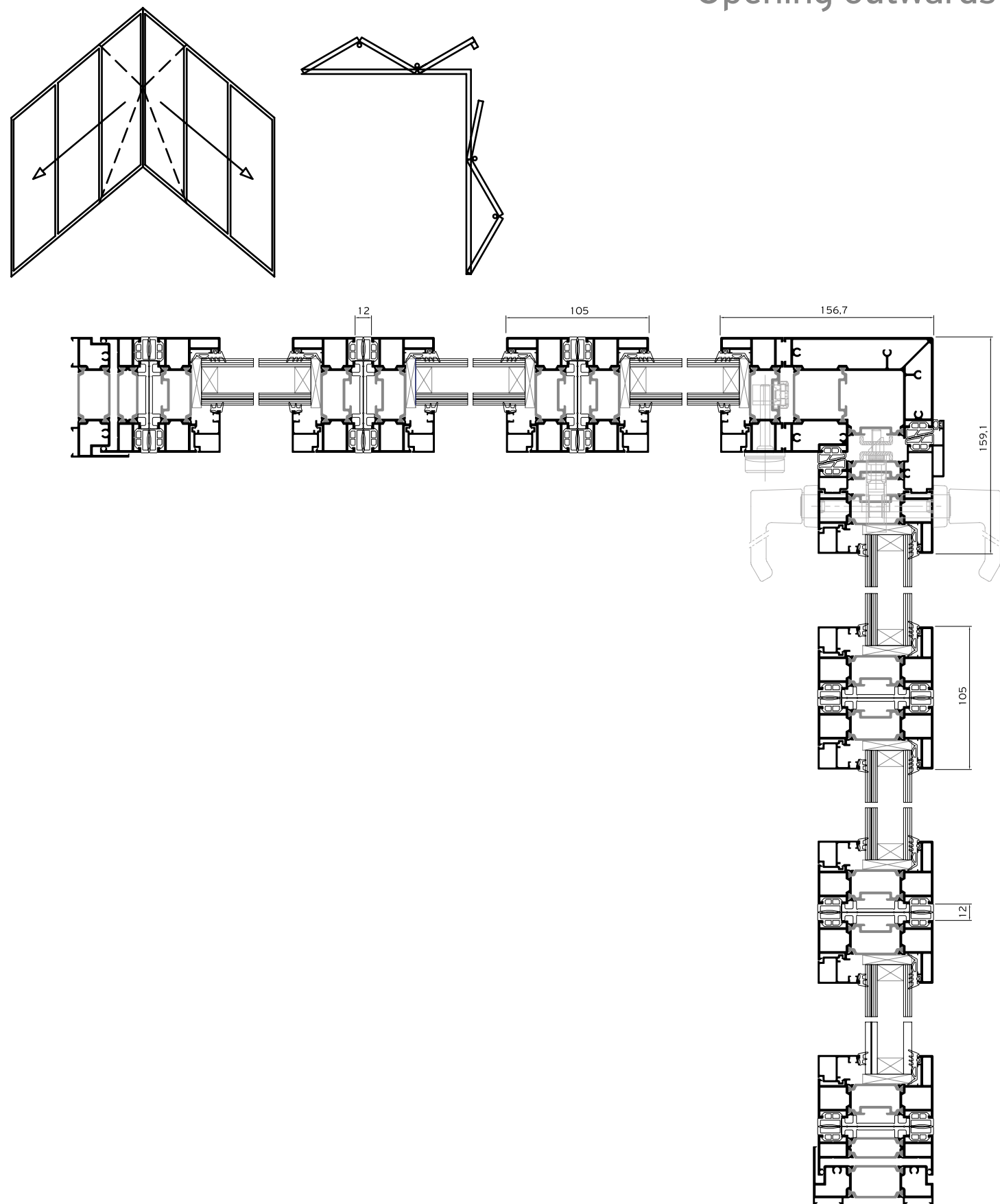

3+2 External Corner Opening outwards

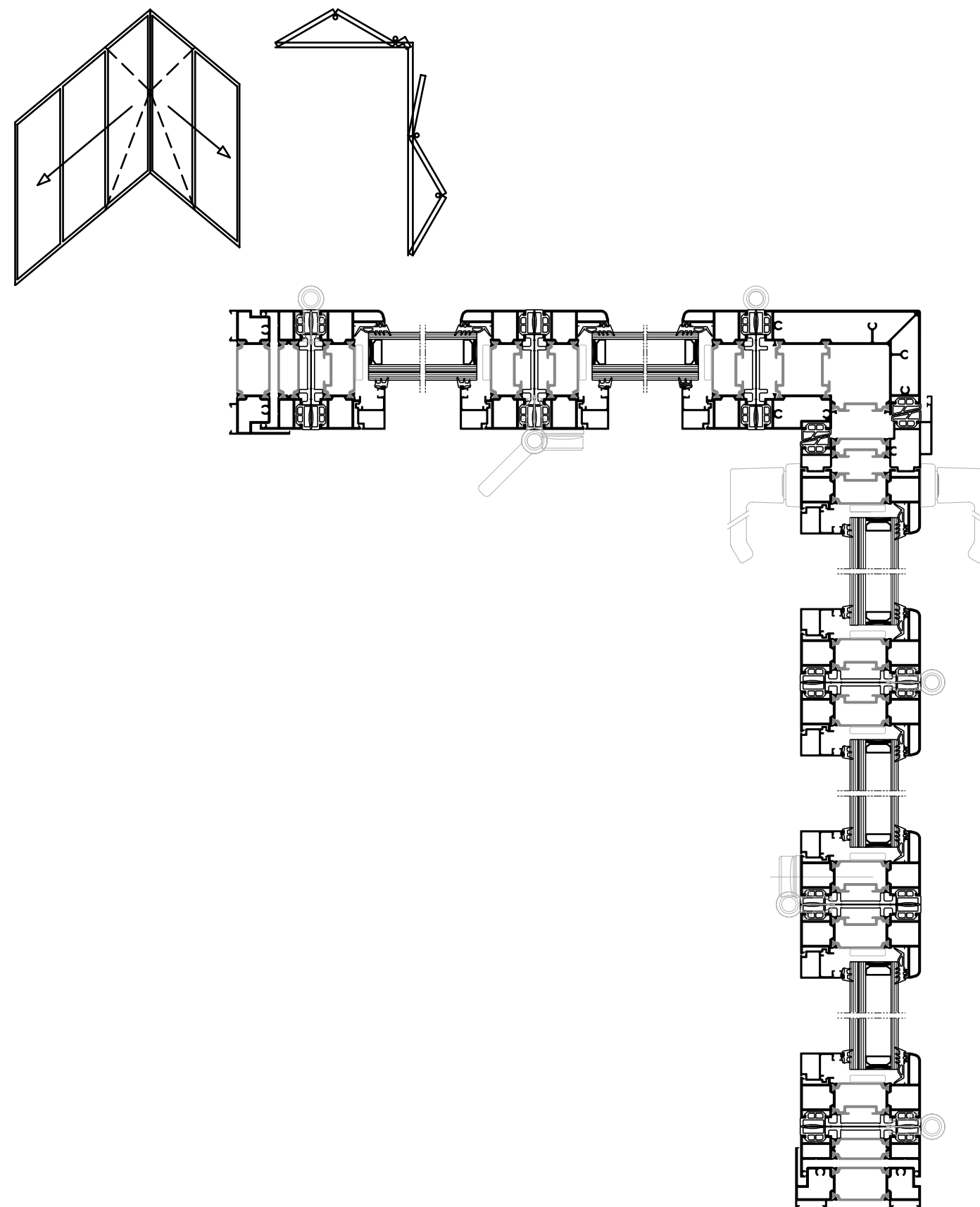

2+3
Internal Corner
Opening inwards

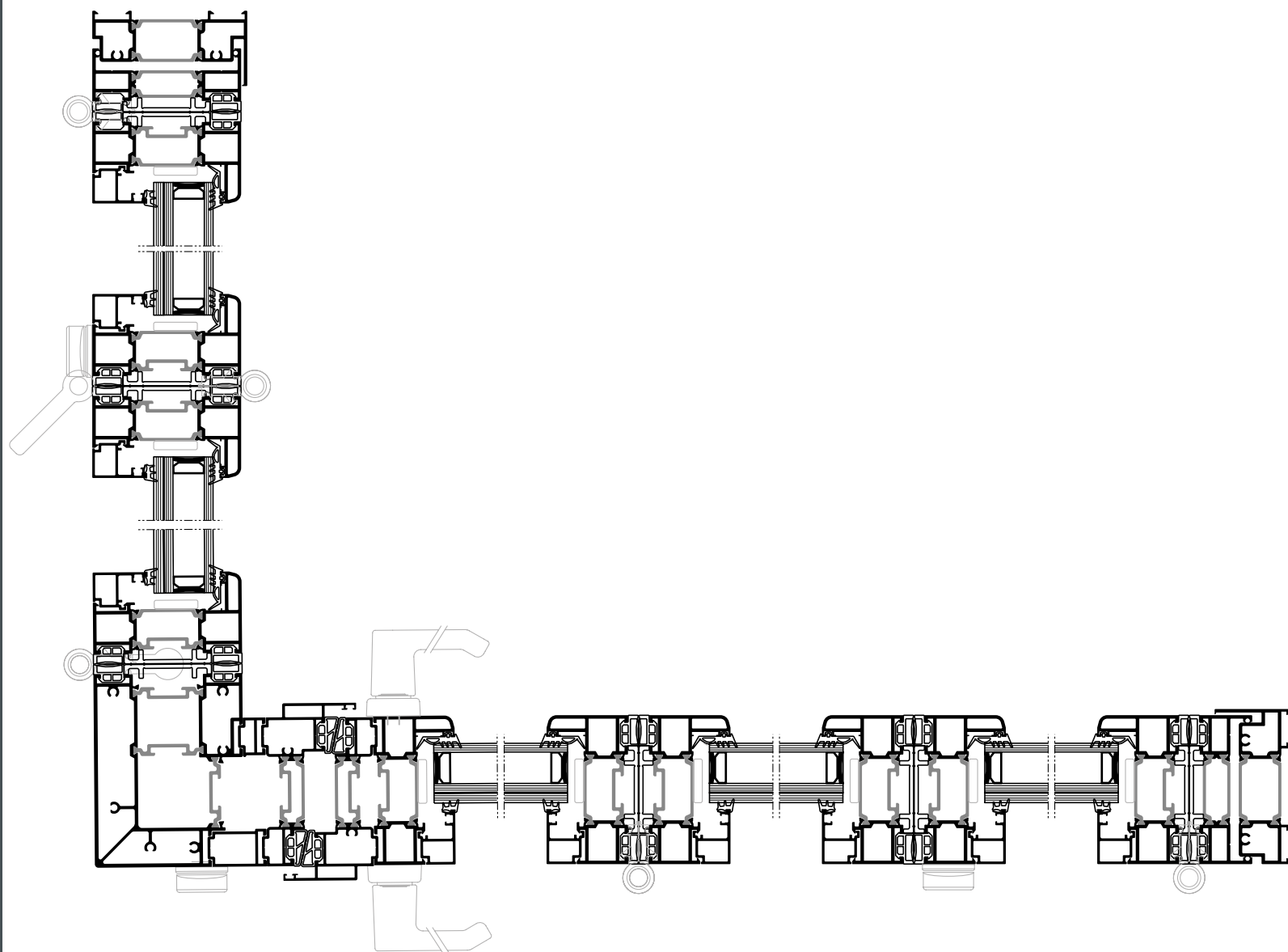
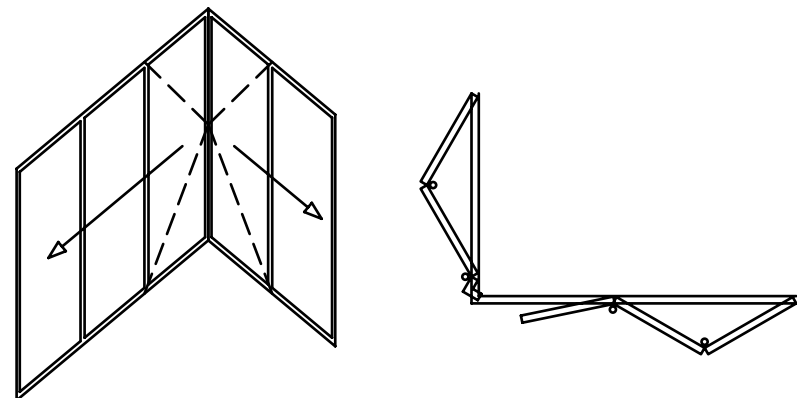

2+2
Internal Corner
Opening outwards

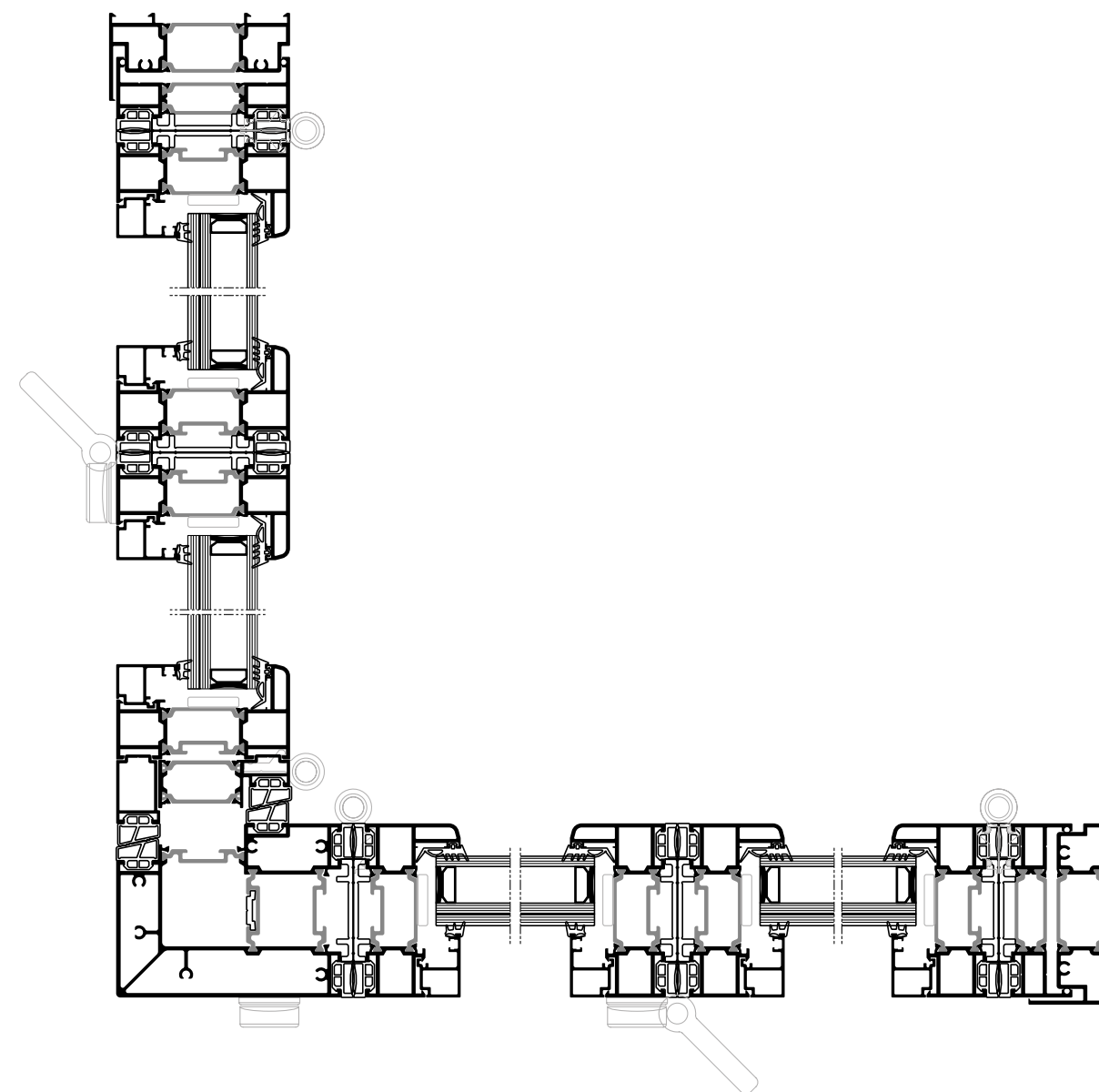
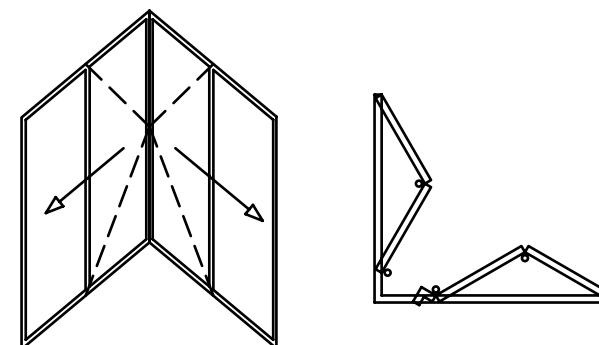

3+0

Semi - Structural
Opening outwards

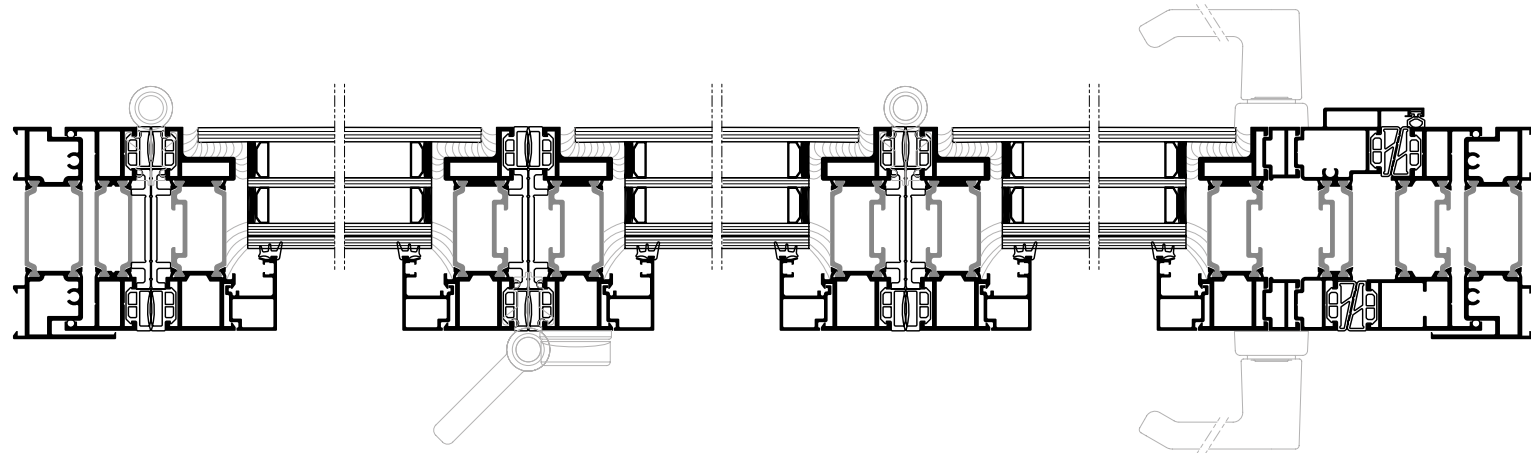
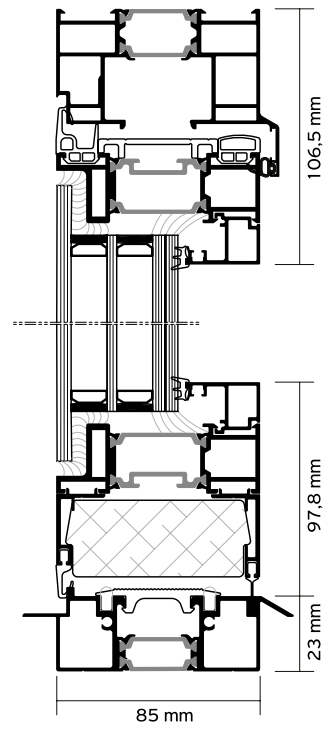
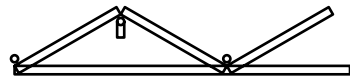
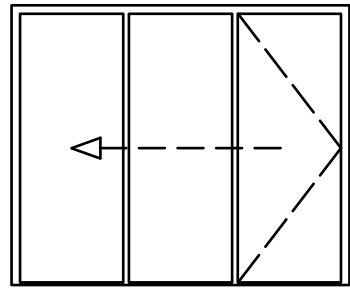

3+1

Semi - Structural
Opening outwards

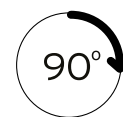
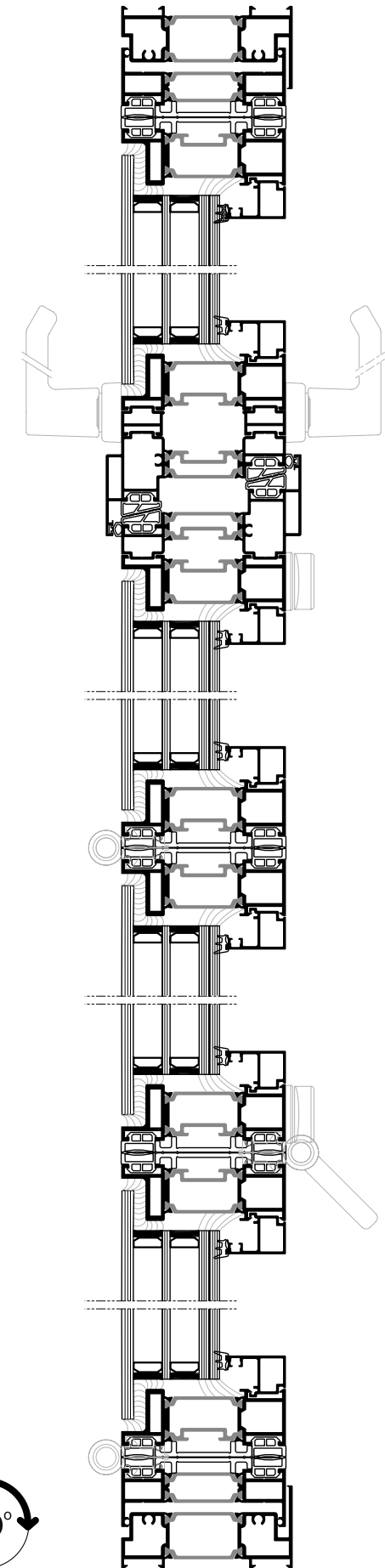
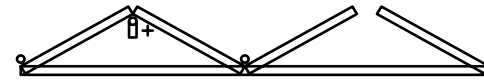
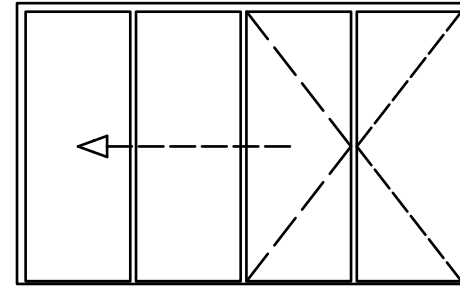

Applications

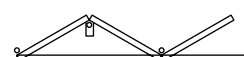
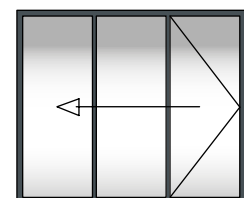

n+0

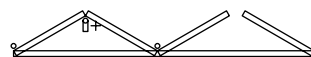
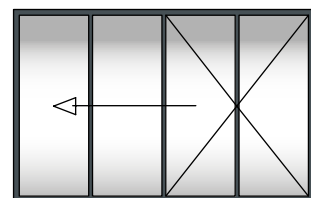

n+1

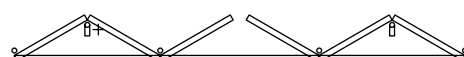
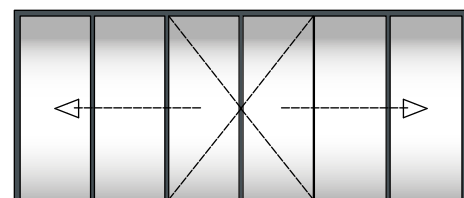

n+n

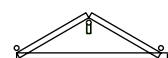
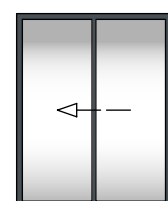

m+0

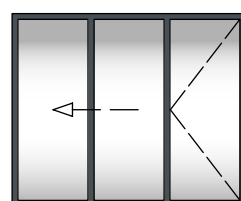

m+1

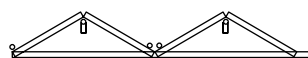
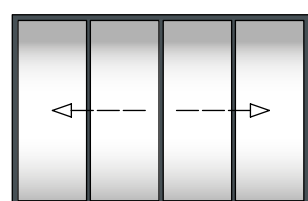

m+m

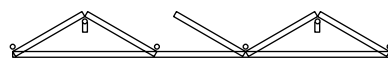
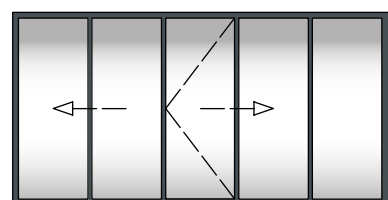

m+n

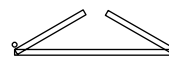
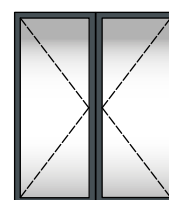

1+1

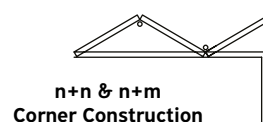
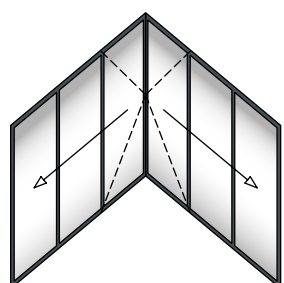

n+n & n+m
Corner Construction

All typologies are compatible with:

- / standard (glazing bead) and semi-structural sash.
- / standard and low threshold (embedded).
- / straight and corner structures.
- / outward or inward opening.

* "n" for odd number (e.g. 7) ⊕ "m" for even (e.g. 6).

Table of performance

CERTIFICATION



WATER TIGHTNESS
EN 12208:1999-11



AIR PERMEABILITY
EN 12207:2016-12



WIND LOAD RESISTANCE
MAX TEST PRESSURE
EN 12210:2016-03

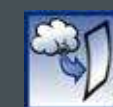

WIND LOAD RESISTANCE
TO FRONTAL DEFLECTION
EN 12210:2016-03

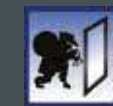

BURGLAR RESISTANCE
EN 1627 - 1630



BURGLAR RESISTANCE
PAS24 (UK)

CLASSIFICATION

1 A (0 Pa)	2 A (50 Pa)	3 A (100 Pa)	4 A (150 Pa)	5 A (200 Pa)	6 A (250 Pa)	7 A (300 Pa)	8 A (450 Pa)	9 A (600 Pa)
1 (150 Pa)		2 (300 Pa)		3 (600 Pa)		4 (600 Pa)		
1 (400 Pa)		2 (800 Pa)		3 (1200 Pa)	4 (1600 Pa)		5 (2000 Pa)	
A (≤ 1/150)				B (≤ 1/200)			C (≤ 1/300)	
RC 1				RC 2			RC 3	
Compliant								

THERMAL PERFORMANCE

	DIMENSIONS IN MM (W x H)	U_w in W/m²K (U_g = 0,6)	U_w in W/m²K (U_g = 0,8)	U_w in W/m²K (U_g = 1,1)
3+0	2.6 x 3.0 m	0,998	1,149	1,39
3+0	3.3 x 3.0 m	0,943	1,102	1,351
3+0	3.9 x 3.5 m	0,894	1,059	1,316

www.alumil.com

DISCOVER MORE:



**ALUMIL
HEAD OFFICES
& SHOWROOM - THESSALONIKI**

GOGOUSI 8, EFKARPIA
THESSALONIKI - GR 56429
TEL.: +30 2313011000
FAX.: +30 231692473
E-MAIL.: info@alumil.com

**ALUMIL
HEADQUARTERS**

KILKIS INDUSTRIAL AREA
KILKIS - GR 61100
TEL.: +30 23410 79300
FAX.: +30 23410 71988
E-MAIL.: info@alumil.com



**ALUMIL
HEAD OFFICES
& SHOWROOM - THESSALONIKI**

GOGOUSI 8, EFKARPIA
THESSALONIKI - GR 56429

TEL.: +30 2313 011000
FAX.: +30 2310 692473
EMAIL.: info@alumil.com

**ALUMIL
HEADQUARTERS**

LUXURY HOTEL
KILKIS INDUSTRIAL AREA
KILKIS - GR 61100

TEL.: +30 23410 79300
FAX.: +30 23410 71988
EMAIL.: info@alumil.com

www.alumil.com

alumil